



Thule Rapid System Kit 4036

> Instructions

KIA Carens, 5-dr MPV, 13-
KIA Rondo, 5-dr MPV, 13-

This kit is only for vehicles with flush or integrated side railing.

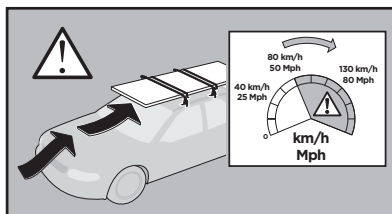
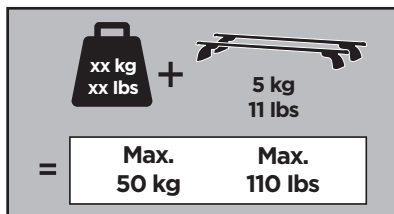
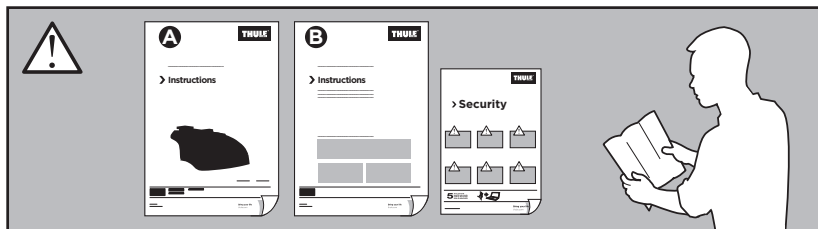

ISO 11154-E

184036

C.20130907
509-4036-02

Bring your life
thule.com

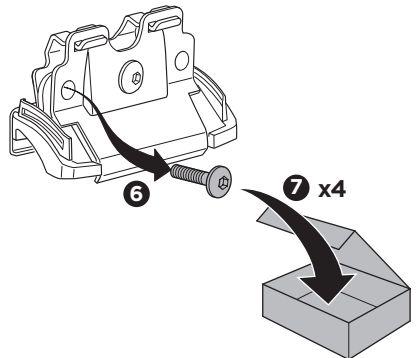
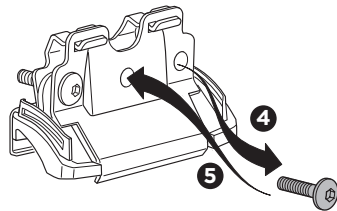
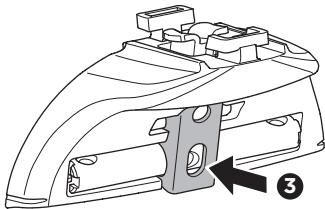
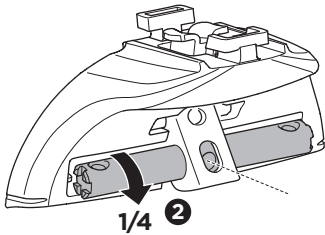
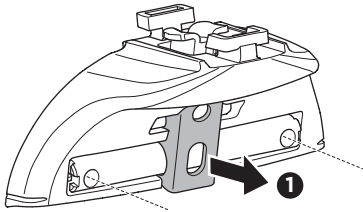
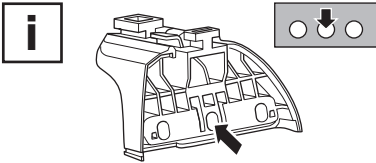
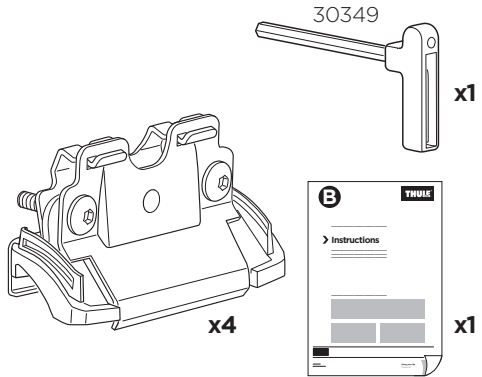
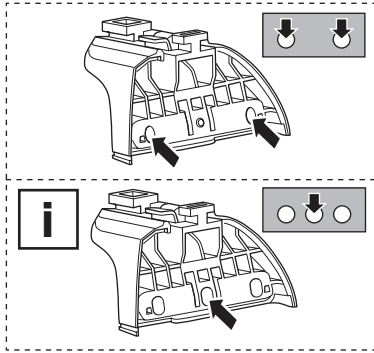

1

EN Only a few turns	ET Ainult mõni pööre	RO Doar câteva rotiri
DE Nur wenige Umdrehungen	LV Tikai daži apgriezieni	HU Csak néhány fordítás
FR Quelques tours uniquement	LT Tik keli pasukimai	EL Μόνο λίγες περιστροφές
NL Slechts enkele slagen	PL Wystarczy kilka obrotów	TR Yalnızca birkaç tur
IT Solo qualche giro	RU Только несколько оборотов	بعض دورات فقط AR
ES Sólo algunas vueltas	UK Лише декілька обертів	רק מספר סיבובים HE
PT Noções básicas	BG Само няколко завъртания	ZH 仅几圈
SV Endast några varv	CS Pouze několik otáček	JA 2～3回転のみ
DK Kun nogle få omgange	SK Len niekoľko otáčok	KO 몇 번만 돌리면 됨
NE Bare noen få omdreininger	SL Le nekaj obratov	TH เพียงสองสามรอบ
FI Vain muutama kierros	HR/BIH Samo nekoliko okreta	

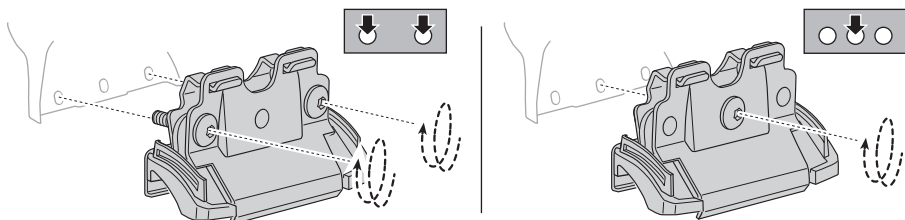
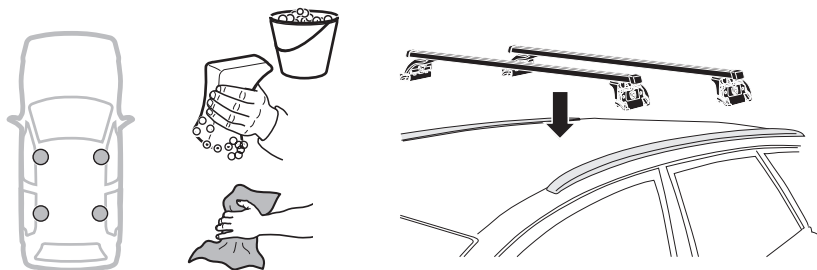
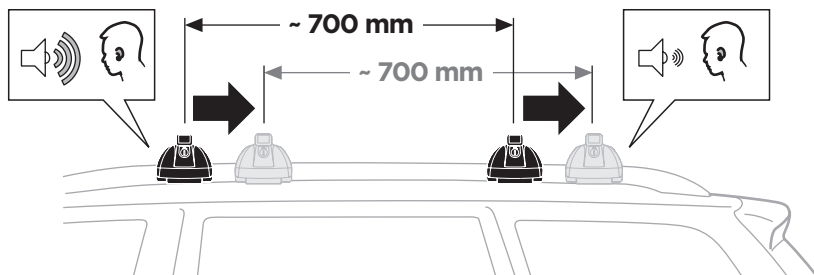
**i****2**

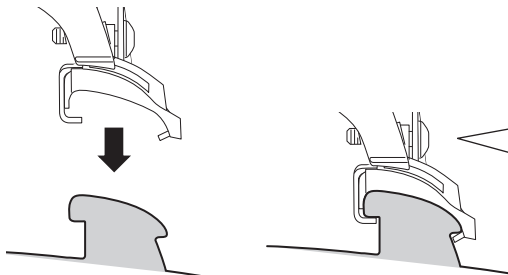
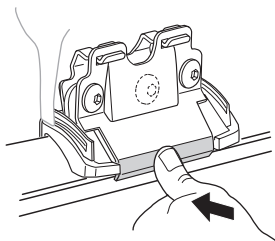
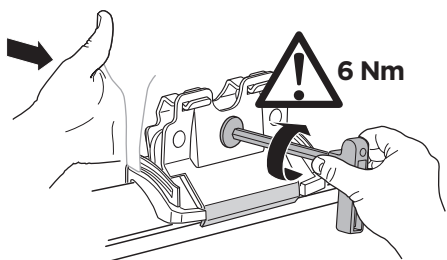
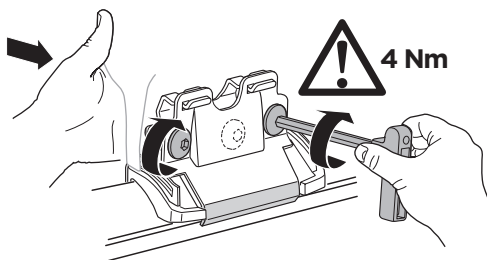
A**B****C**

- EN** Tighten alternately
DE Die Schrauben abwechselnd anziehen
FR Serrer alternativement chaque côté
NL Afwisselend aan de linker- en de rechterkant aandraaien
IT Alternare il serraggio delle viti
ES Apretar alternativamente
PT Aperte alternadamente
SV Dra åt växelvis
DK Spænd skiftevis
NE Trekk til vekselvis
FI Kierrä vuorotellen
ET Pinguldage vaheldumisi
LV Pievelciēt pamīšus
LT Užsukinėkite pakaitomis
PL Śruby dokręcaj naprzemiennie
RU Затягивайте попеременно
UK Затягти по чергово
BG Затегнете последователно
CS Pokręťta bagazníka dokręcaj dokręcaj naprzemiennie.
SK Doťahujte striedavo
SL Privijajte izmenično
HR/BiH Naizmjenočno zategnite
RO Strângeți alternativ
HU Egymástól függetlenül szorítandó
EL Ζφίξητε εναλλάξ
TR Dönüşümlü sıkın

AR إحكام الربط بالتناوب
 HE חזק לסיורון

- ZH** 交替拧紧
JA 自動固定
KO 번갈아 조이기
TH สลับขันสกรู

